

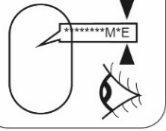

4043 - CADDY 2020

PRODUCT/ÜRÜN : 850 – AB-NS

ser.nr:



M6 = 10 Nm
M8 = 25 Nm
M10 = 50 Nm



KAYNAKLI PARÇA İÇERİR

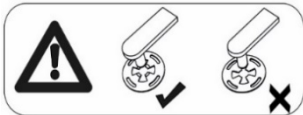
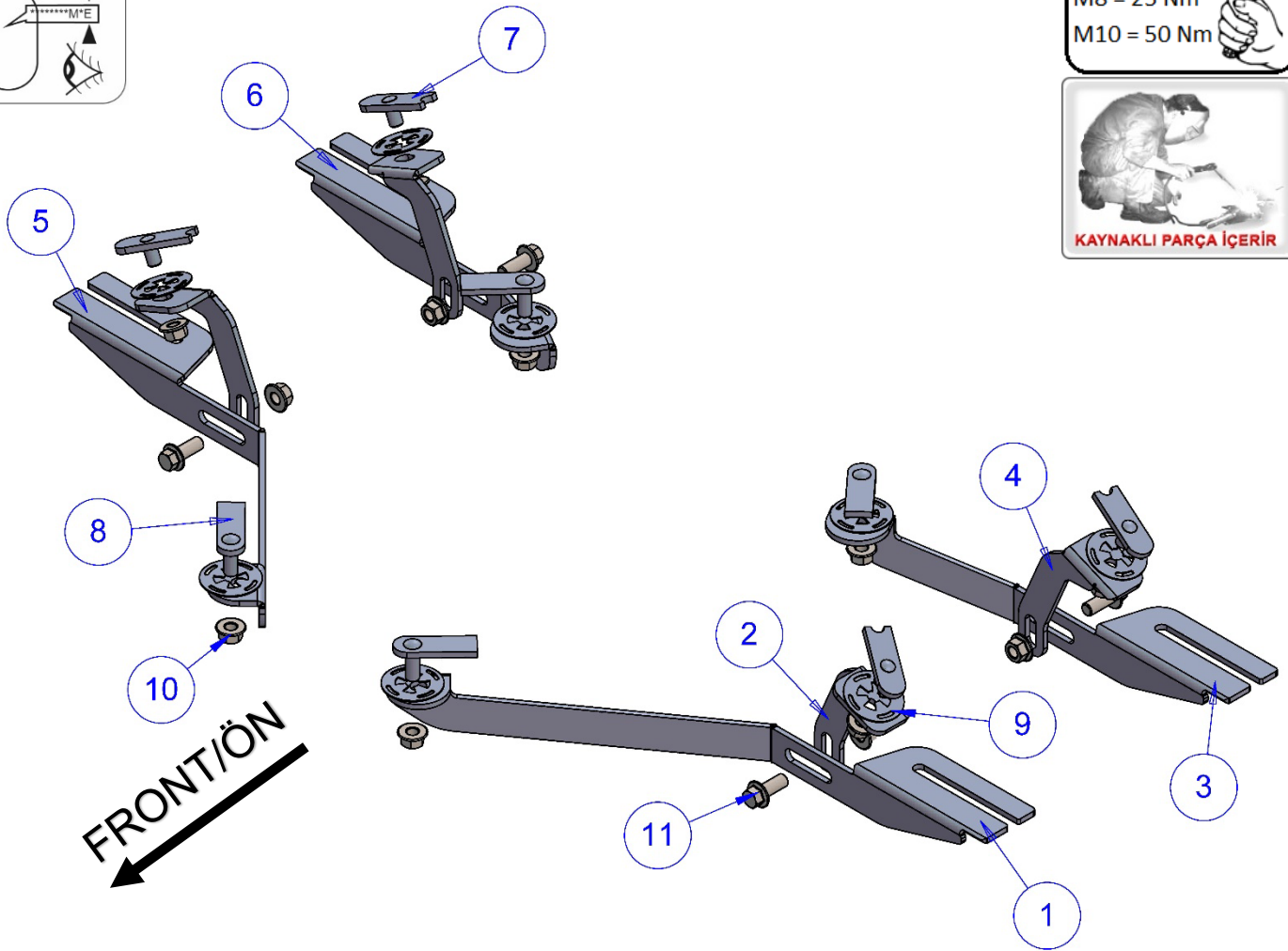

ITEM NO.	PART NUMBER	QTY.
1	4043850F0	1
2	4043850FB1	2
3	4043850B0	1
4	Mirror4043850FB1	2
5	Mirror4043850F0	1
6	Mirror4043850B0	1
7	HTC 321 - M10x15(5x20x60)	4
8	HTC 230 - M10x25(5x20x60)	4
9	HTC 269 - CLIPS (M10)	8
10	DIN 6923 FLANGE NUT - M10	12
11	DIN 6921 FLANGE BOLT - M10 X 25	4

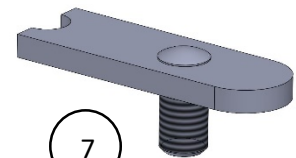

7



8



9

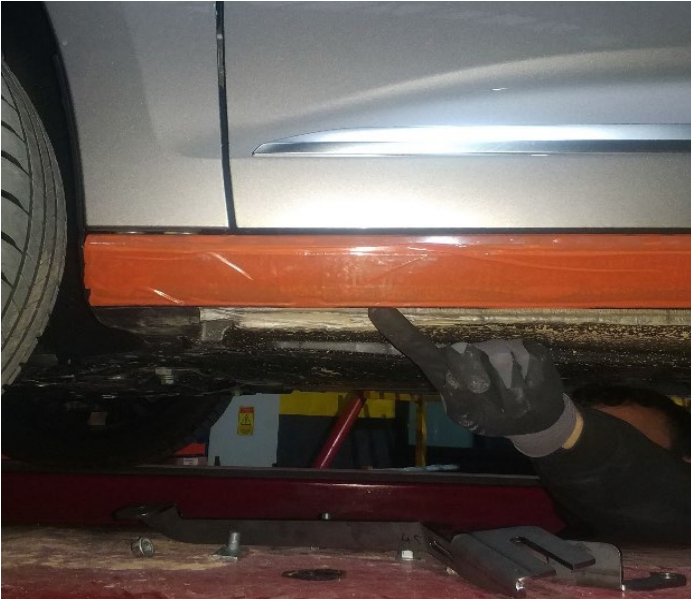
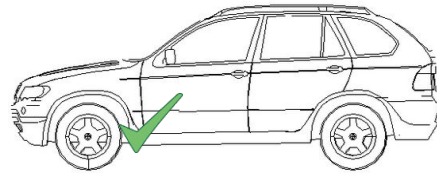

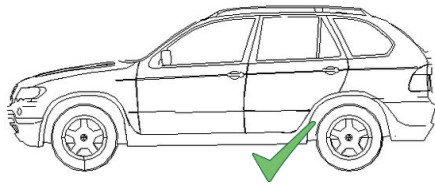



4043 – CADDY 2021

